

This is a pre print version of the following article:

A Continuum Model for Circular Graphene Membranes Under Uniform Lateral Pressure / Pellicciari, M; Tarantino, Am. - In: JOURNAL OF ELASTICITY. - ISSN 0374-3535. - 151:2(2022), pp. 273-303. [10.1007/s10659-022-09937-w]

Terms of use:

The terms and conditions for the reuse of this version of the manuscript are specified in the publishing policy. For all terms of use and more information see the publisher's website.

06/05/2026 22:01

(Article begins on next page)

A continuum model for circular graphene membranes under uniform lateral pressure

Matteo Pelliciarì · Angelo Marcello Tarantino

Received: - / Accepted: -

Abstract Despite the numerous applications of pressurized graphene membranes in new technologies, there is still a lack of accurate mechanical models. In this work we propose a continuum model for circular graphene membranes subjected to uniform lateral pressure. We adopt a semi-inverse method by defining the kinematics of deformation and we describe the material behavior with a stored energy function that takes into account both nonlinearity and anisotropy of graphene. From the equilibrium we obtain an expression of the applied pressure as a function of the deflection of the membrane. A finite element (FE) model in nonlinear elasticity is presented and the results are used to validate the analytical model. A comparison with other models, numerical simulations and experiments from the literature demonstrates the advantages of the model proposed in this work. Differently from our entirely nonlinear approach, all the continuum models in the literature are based on the assumption of linear elastic material, which is suitable only when deformations are small. The present model gives a comprehensive description of the mechanics of pressurized graphene membranes.

Keywords Graphene membrane · Nonlinear elasticity · Anisotropy · Hyperelasticity · Finite element

Mathematics Subject Classification (2010) 74B20 · 74G05 · 74K15 · 74S05 · 74E10

1 Introduction

Numerous applications in new technologies involve the use of graphene. The extraordinary mechanical, thermal and electrical properties of this material attracted the interest of researchers from many engineering fields. In fact, graphene is used in micro-and nano-electronic devices [37, 46], biomedicine [38], nanocomposite materials [5, 27, 36], energy generation and storage [33, 35], electrochemical sensors [14], and many other applications.

Graphene membranes are impermeable to standard gases and therefore they are often used for pressure sensors [2]. Pressurized graphene membranes provide a one-atom-thick separation barrier that can support large

M. Pelliciarì
DIEF, Department of Engineering “Enzo Ferrari”, via Pietro Vivarelli 10, 41125 Modena, Italy
Tel.: +39 3334858333
E-mail: matteo.pelliciarì@unimore.it

A. M. Tarantino
DIEF, Department of Engineering “Enzo Ferrari”, via Pietro Vivarelli 10, 41125 Modena, Italy
E-mail: angelomarcello.tarantino@unimore.it

pressure differences. Liu et al. [21] reported the outstanding molecular separation properties of graphene membranes, which can be applied to pressure filtration, pervaporation and gas separation. Graphene membranes are also used as piezoresistive pressure sensors [48] and as pressure sensors for detecting human motions [39]. Wang et al. [43] presented a graphene-based microelectromechanical system (MEMS) pressure sensor and showed that, thanks to its high sensitivity, it outperforms most existing MEMS sensors. Moreover, polymer nanocomposite membranes based on graphene find new and promising technological applications [15, 24].

Despite the enormous potential of pressurized graphene membranes, there is still a lack of accurate mechanical models. Wang et al. [42] analyzed the problem of circular graphene membranes subjected to uniform lateral pressure and proposed approximated analytical solutions based on the assumption of linear elastic material. They carried out molecular dynamics simulations on a nanoscale membrane and it was found that the approximated solutions are suitable only for small deflections (linear elasticity). Jiang et al. [13] and Wang et al. [40] carried out FE simulations by modeling the graphene sheet with, respectively, plate and shell elements composed of linear elastic material. Li et al. [20] proposed a continuum model based on the large deflection elastic theory of circular membranes and investigated the effect of variations of the membrane parameters by using FE simulations.

The above models are all based on the hypothesis of linear elastic constitutive response of graphene. However, experiments and numerical simulations showed that graphene exhibits a pronounced material nonlinearity, which derives from the nonlinear carbon-carbon interactions in the hexagonal lattice [19, 22, 30, 32]. In addition, graphene is isotropic only for infinitesimal deformations, while in the theory of large deformations its anisotropy must be taken into account [12]. This behavior of graphene is not considered in the models mentioned above. Against this background, there are still important issues that must be addressed to provide a comprehensive description of the mechanics of circular pressurized graphene membranes.

In the present work, we derive a solution to this problem in finite elasticity. We adopt a semi-inverse method by defining the kinematics of deformation of the circular pressurized membrane. Consequently, we consider the anisotropic hyperelastic material model for graphene proposed by Höller et al. [11] and we derive the stress measures. The equilibrium is then written and an expression of the applied pressure as a function of the deflection of the central point of the membrane is derived. Differently from the other models in the literature, the material nonlinearity of graphene is accurately described.

The proposed analytical model is validated with the results of a FE simulation. The FE simulation was carried out in software COMSOL Multiphysics. Both material and geometric nonlinearities were considered. After validating the model, we present a comparison with other results from experiments and simulations found in the literature. The comparison demonstrates the advantages of the present model and points out the importance of considering the nonlinear material response of graphene.

The model proposed in this work represents a straightforward tool for an accurate analysis of the mechanics of pressurized graphene membranes. Having at hand a direct expression of pressure as a function of deflection is a great advantage. Instead, atomistic and FE simulations are complex and require high computational effort.

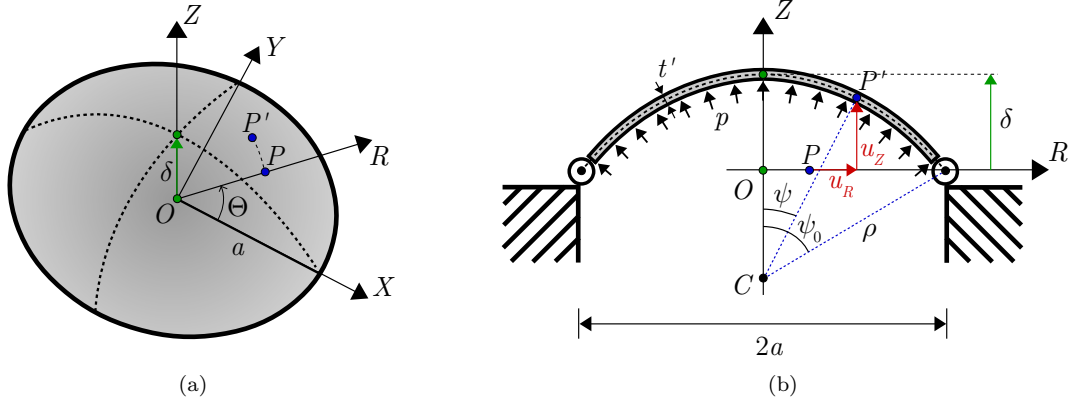

Fig. 1: (a) Circular graphene membrane subjected to uniform lateral pressure and (b) kinematics of deformation in the R - Z plane based on the assumption that the membrane transforms into a spherical cap with origin in C .

Especially atomistic simulations, which are accurate but can be applied only to systems composed of a small number of atoms.

The paper is organized as follows. The hyperelastic model for circular graphene membranes under uniform lateral pressure is presented in Section 2. The FE model is described in Section 3. The results are given in Section 4, where we first validate the model and subsequently we present a comparison with other results from the literature. Conclusions are drawn in Section 5.

2 Hyperelastic model for circular graphene membranes subjected to uniform lateral pressure

The circular pressurized graphene membrane is depicted in Fig. 1a. The undeformed flat membrane has radius a and thickness t . We introduce a Cartesian coordinate system (X, Y, Z) and a cylindrical coordinate system (R, Θ, Z) , both with origin in O . Directions X and Y correspond respectively to zigzag and armchair directions in the graphene hexagonal lattice [3, 17]. The membrane is subjected to the uniform pressure p and material point P moves to P' . We assume that the membrane preserves its rotational symmetry after deformation, therefore $\Theta' = \Theta$. The coordinates of P' in deformed configuration are (R', Θ, Z') .

We assume that the initially flat membrane transforms into a spherical cap. Note that the ultimate strain of graphene subjected to uniaxial elongation is around 15-20% [41, 44, 47]. Since the deformations involved are moderately large, the assumption that the membrane transforms into a spherical cap gives an appropriate description of the kinematics of deformation [45]. This hypothesis will be validated by the FE simulation of Section 3.

The membrane deforms according to the kinematics of Fig. 1b. The spherical cap is centered in point C and has radius ρ . Displacement field $\mathbf{u}(P)$ of point P with coordinates $(R, \Theta, 0)$ has the following expression

64 in cylindrical coordinates:

$$\begin{aligned} u_R(P) &= R' - R = \rho \sin \psi - R, \\ u_\Theta(P) &= 0, \\ u_Z(P) &= Z' = \rho (\cos \psi - \cos \psi_0), \end{aligned}$$

65 where $\psi_0 \in (0, \pi)$ and

$$\rho = \frac{a}{\sin \psi_0}, \quad \psi = \frac{\psi_0 R}{a}.$$

66 The deformation of point P is $\boldsymbol{\varphi}(P) = \mathbf{id}(P) + \mathbf{u}(P)$ ¹ and its representation in cylindrical coordinates is

$$\begin{aligned} \varphi_R(P) &= \rho \sin \psi, \\ \varphi_\Theta(P) &= \Theta, \\ \varphi_Z(P) &= \rho (\cos \psi - \cos \psi_0). \end{aligned}$$

67 In order to derive the deformation gradient \mathbf{F} we must introduce the contraction of the membrane thickness,
68 which is expressed by stretch λ_Z . However, we are considering a single-layer graphene sheet whose thickness
69 corresponds to the diameter of the carbon atom. From a physical point of view it is not possible that such thin
70 membrane undergoes a transverse contraction, because it would produce a reduction of the dimension of the
71 atom. In light of this, the only possible and reasonable assumption is that $\lambda_Z = 1$ throughout the deformation
72 process. Hence, thickness t of the undeformed membrane remains unchanged ($t' = t$). The deformation gradient
73 is thus derived as follows:

$$[\mathbf{F}] = \begin{bmatrix} \frac{\partial \varphi_R}{\partial R} & \frac{1}{R} \frac{\partial \varphi_R}{\partial \Theta} & \sin \psi \\ \varphi_R \frac{\partial \varphi_\Theta}{\partial R} & \frac{\varphi_R}{R} \frac{\partial \varphi_\Theta}{\partial \Theta} & 0 \\ \frac{\partial \varphi_Z}{\partial R} & \frac{1}{R} \frac{\partial \varphi_Z}{\partial \Theta} & \cos \psi \end{bmatrix} = \begin{bmatrix} \rho \frac{\partial \psi}{\partial R} \cos \psi & 0 & \sin \psi \\ 0 & \frac{\rho \sin \psi}{R} & 0 \\ -\rho \frac{\partial \psi}{\partial R} \sin \psi & 0 & \cos \psi \end{bmatrix}.$$

74 The polar decomposition of the deformation gradient, $\mathbf{F} = \mathbf{R}\mathbf{U}$, allows us to write rotation tensor \mathbf{R} and pure
75 deformation tensor \mathbf{U} as

$$[\mathbf{R}] = \begin{bmatrix} \cos \psi & 0 & \sin \psi \\ 0 & 1 & 0 \\ -\sin \psi & 0 & \cos \psi \end{bmatrix}, \quad [\mathbf{U}] = \begin{bmatrix} \rho \frac{\partial \psi}{\partial R} & 0 & 0 \\ 0 & \frac{\rho \sin \psi}{R} & 0 \\ 0 & 0 & 1 \end{bmatrix}. \quad (1)$$

76 Tensor \mathbf{U} is diagonal and therefore the cylindrical coordinate system (R, Θ, Z) is principal. Hence, from (1) we
77 derive the following expressions of the principal stretches:

$$\lambda_R = \rho \frac{\partial \psi}{\partial R} = \frac{\rho \psi_0}{a}, \quad \lambda_\Theta = \frac{\rho \sin \psi}{R}. \quad (2)$$

¹ $\mathbf{id}(P)$ indicates the position vector of point P .

78 Radial stretch λ_R is not a function of position because we assumed that the membrane deforms into a
79 spherical cap.

80 The right Cauchy-Green deformation tensor, $\mathbf{C} = \mathbf{F}^T \mathbf{F}$, is computed and expressed in cylindrical coordinates
81 as

$$[\mathbf{C}] = \begin{bmatrix} \lambda_R^2 & 0 & 0 \\ 0 & \lambda_\Theta^2 & 0 \\ 0 & 0 & 1 \end{bmatrix},$$

82 with λ_R and λ_Θ given by (2). The Green-Lagrange strain tensor, $\mathbf{E} = (\mathbf{C} - \mathbf{I})/2$, has the following diagonal
83 form:

$$[\mathbf{E}] = \begin{bmatrix} E_R & 0 & 0 \\ 0 & E_\Theta & 0 \\ 0 & 0 & E_Z \end{bmatrix} = \frac{1}{2} \begin{bmatrix} \lambda_R^2 - 1 & 0 & 0 \\ 0 & \lambda_\Theta^2 - 1 & 0 \\ 0 & 0 & 0 \end{bmatrix}. \quad (3)$$

84 The extensive number of investigations on the mechanical behavior of graphene demonstrated that this
85 material is isotropic only for small deformations, while anisotropy arises when deformations become large
86 [12, 26]. This is due to the particular symmetry and periodicity of the graphene honeycomb lattice. To this
87 regard, Kumar and Parks [18] used the isotropization theorem [34] to define an additional invariant of
88 the Green-Lagrange strain tensor that reproduces the anisotropic nature of graphene. We introduce tensors
89 $\mathbf{M} = \mathbf{n}_X \otimes \mathbf{n}_X - \mathbf{n}_Y \otimes \mathbf{n}_Y$ ² and $\mathbf{N} = \mathbf{n}_X \otimes \mathbf{n}_Y + \mathbf{n}_Y \otimes \mathbf{n}_X$, which define the material symmetry group of graphene.
90 Thereby, the strain energy density of graphene is written as a function of the following strain invariants:

$$\begin{aligned} I_1 &= \text{tr} \mathbf{E} = E_R + E_\Theta, \\ I_2 &= \frac{1}{2} \left[(\text{tr} \mathbf{E})^2 - \text{tr} (\mathbf{E}^2) \right] = E_R E_\Theta, \\ I_3 &= (\mathbf{M} \cdot \mathbf{E})^3 - 3 (\mathbf{M} \cdot \mathbf{E}) (\mathbf{N} \cdot \mathbf{E})^2 = (E_R - E_\Theta)^3 \cos(6\phi), \end{aligned} \quad (4)$$

91 where $\phi \in [0, \pi/6]$ and it represents the angle that principal direction 1 forms with zigzag direction (Fig. 2).
92 Symmetry and periodicity of graphene allows us to investigate its material behavior in the domain between
93 zigzag and armchair directions, inside which $\phi = \Theta$. Note that, in (4), I_1 and I_2 are the isotropic principal
94 invariants of the Green-Lagrange strain tensor [29]. Anisotropy is introduced with the third invariant I_3 , which
95 plays a role only when deformations are relatively large and $E_R \neq E_\Theta$. Equation (4) is rewritten as a function
96 of the principal stretches as follows:

$$\begin{aligned} I_1 &= \frac{1}{2} (\lambda_R^2 + \lambda_\Theta^2 - 2), \\ I_2 &= \frac{1}{4} (\lambda_R^2 - 1) (\lambda_\Theta^2 - 1), \\ I_3 &= \frac{1}{8} (\lambda_R^2 - \lambda_\Theta^2)^3 \cos(6\phi). \end{aligned} \quad (5)$$

97 In general, circular membranes composed of anisotropic materials lose their rotational symmetry when
98 subjected to uniform lateral pressure. Nevertheless, this effect is negligible for the particular case of graphene

² Unit vectors \mathbf{n}_X and \mathbf{n}_Y identify respectively directions X and Y of the Cartesian coordinate system. Symbols \otimes and (\cdot) denote dyadic product and second-order tensor contraction, respectively.

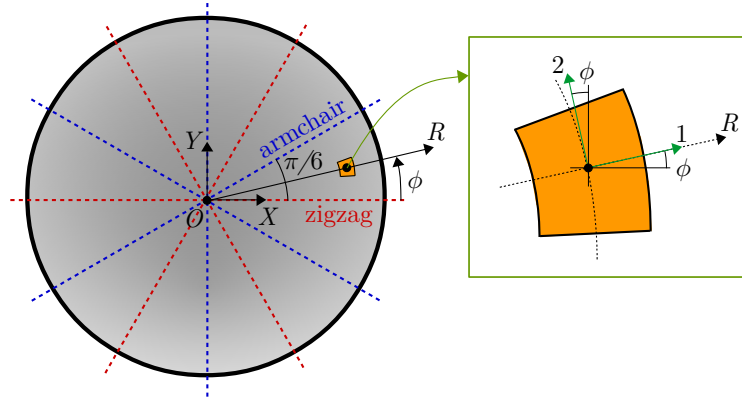

Fig. 2: Representation of the periodicity in the lattice structure of graphene, which repeats itself allowing to study its mechanical response within the domain identified by $\phi \in [0, \pi/6]$.

99 and the reason is as follows. As already pointed out, graphene breaks for deformations that are not very large.
 100 The ultimate value of strain is reached before that invariant I_3 assumes a sensible importance. Specifically,
 101 term $(\lambda_R^2 - \lambda_\Theta^2)^3$ is negligible with respect to the values assumed by the isotropic invariants I_1 and I_2 . Given
 102 the above, the hypothesis of axisymmetric kinematics of deformation is still valid and gives a simplified but
 103 effective description of the actual behavior of graphene. In any case, this assumption will be validated by the
 104 FE simulation, which will be presented in Section 3. It is worth saying that without this hypothesis on the
 105 kinematics it would be impossible to derive an analytical solution for the problem addressed in the present
 106 work. This clarifies the necessity and effectiveness of such assumption.

107 The most innovative and refined stored energy function for graphene was firstly introduced by Höller et
 108 al. [11] by fitting density functional theory (DFT) simulations. Subsequent works [28, 31] showed its validity
 109 and accuracy in the prediction of the graphene response subjected to large in-plane deformations. Therefore,
 110 we assume such hyperelastic material model for graphene. The stored energy function proposed in [11] is

$$\omega(I_1, I_2, I_3) = \frac{1}{t} \sum_{k=1}^3 c_k I_k + \frac{1}{t} \sum_{h=1}^{11} c_{h+3} J_h, \quad (6)$$

111 where $c_1 - c_{14}$ are polynomial fitting coefficients with dimension of energy per unit area, whose values are
 112 reported in Tab. 3 of work [28]. Invariants J_h are defined as polynomial combinations of I_1 , I_2 and I_3 and their
 113 expressions are given in [11]. Being graphene a one-atom-thick layer, it is often treated as a two-dimensional
 114 material. In the expression of the stored energy function (6), we divided by thickness t so as to regard the
 115 graphene membrane as a three-dimensional solid and evaluate stress components with the usual dimension of
 116 force per unit area.

117 The second Piola-Kirchhoff stress tensor is energetically conjugated to the Green-Lagrange strain tensor
 118 and thus it is computed as

$$\Sigma = \frac{\partial \omega}{\partial \mathbf{E}}(I_1, I_2, I_3) = \sum_{k=1}^3 \frac{\partial \omega}{\partial I_k} \frac{\partial I_k}{\partial \mathbf{E}}, \quad (7)$$

119 where the derivatives of the principal invariants with respect to \mathbf{E} are

$$\frac{\partial I_1}{\partial \mathbf{E}} = \mathbf{n}_X \otimes \mathbf{n}_X + \mathbf{n}_Y \otimes \mathbf{n}_Y, \quad \frac{\partial I_2}{\partial \mathbf{E}} = I_1 (\mathbf{n}_X \otimes \mathbf{n}_X + \mathbf{n}_Y \otimes \mathbf{n}_Y) - \mathbf{E}, \quad \frac{\partial I_3}{\partial \mathbf{E}} = \mathbf{S},$$

120 with $\mathbf{S} = 3 [(\mathbf{M} \cdot \mathbf{E})^2 - (\mathbf{N} \cdot \mathbf{E})^2] \mathbf{M} - 6 [(\mathbf{M} \cdot \mathbf{E})(\mathbf{N} \cdot \mathbf{E})] \mathbf{N}$, whose representation in the cylindrical coordinate

121 system is

$$[\mathbf{S}] = 3 (E_R - E_\Theta)^2 \begin{bmatrix} \cos(6\phi) & -\sin(6\phi) & 0 \\ -\sin(6\phi) & -\cos(6\phi) & 0 \\ 0 & 0 & 0 \end{bmatrix}.$$

122 We introduce invariants β_1 , β_2 and β_3 , defined as

$$\begin{aligned} \beta_1 &= c_1 + c_2 I_1 - 3c_5 I_2 + c_6 (I_1^2 + I_2) - 4c_7 I_1 I_2 + 2c_8 I_1 I_2 + c_9 (I_1^3 - 2I_1 I_2) \\ &\quad + 5c_{10} (I_2^2 - I_1^2 I_2) + c_{11} (I_1^4 - 3I_2^2 - 3I_1^2 I_2) + c_{12} (I_2^2 + 2I_1^2 I_2) + c_{13} I_3, \\ \beta_2 &= -c_2 + 2c_4 + 3c_5 I_1 - c_6 I_1 + 4c_7 (I_1^2 - I_2) - 2c_8 I_2 + c_9 (4I_2 - I_1^2) \\ &\quad + 5c_{10} (I_1^3 - 2I_1 I_2) + c_{11} (6I_1 I_2 - I_1^3) - 2c_{12} I_1 I_2 + 2c_{14} I_3, \\ \beta_3 &= c_3 + c_{13} I_1 + c_{14} (I_1^2 - 2I_2). \end{aligned} \quad (8)$$

123 From (7) we derive the following expressions for the components of the symmetric second Piola-Kirchhoff

124 stress tensor:

$$\begin{aligned} \Sigma_{RR} &= \frac{\beta_1}{t} + \frac{\beta_2}{2t} (\lambda_R^2 - 1) + \frac{3\beta_3}{4t} (\lambda_R^2 - \lambda_\Theta^2)^2 \cos(6\phi), \\ \Sigma_{\Theta\Theta} &= \frac{\beta_1}{t} + \frac{\beta_2}{2t} (\lambda_\Theta^2 - 1) - \frac{3\beta_3}{4t} (\lambda_R^2 - \lambda_\Theta^2)^2 \cos(6\phi), \\ \Sigma_{R\Theta} &= -\frac{3\beta_3}{4t} (\lambda_R^2 - \lambda_\Theta^2)^2 \sin(6\phi), \\ \Sigma_{RZ} &= \Sigma_{\Theta Z} = \Sigma_{ZZ} = 0. \end{aligned} \quad (9)$$

125 It is assumed that the graphene undeformed configuration is stress free and therefore $c_1 = 0$.

126 Having at hand the second Piola-Kirchhoff stress tensor, the other stress measures can be derived. The

127 first Piola-Kirchhoff stress tensor, $\mathbf{T}_R = \mathbf{F}\boldsymbol{\Sigma}$, reads

$$[\mathbf{T}_R] = \begin{bmatrix} \lambda_R \Sigma_{RR} \cos \psi & \lambda_R \Sigma_{R\Theta} \cos \psi & 0 \\ \lambda_\Theta \Sigma_{R\Theta} & \lambda_\Theta \Sigma_{\Theta\Theta} & 0 \\ -\lambda_R \Sigma_{RR} \sin \psi & -\lambda_R \Sigma_{R\Theta} \sin \psi & 0 \end{bmatrix}. \quad (10)$$

128 We immediately observe that, as required by the plane stress state, boundary conditions $\pm \mathbf{T}_R \mathbf{n}_Z = \mathbf{0}$ are

129 satisfied. This guarantees that the two external faces of the membrane are traction-free and all the stress

130 components act in the plane of the deformed membrane. \mathbf{T}_R is not diagonal in reference system (R, Θ, Z) ,

131 which is principal regarding the deformation. Hence, the principal strain directions do not coincide with the

132 principal stress directions. This is not a surprise given that graphene is described by an anisotropic material

133 model. In order to write the equilibrium in deformed configuration, we now derive the Cauchy stress tensor

134 $\mathbf{T} = \mathbf{T}_R \mathbf{F}^T / \det \mathbf{F}$. By definition, tensor \mathbf{T} is symmetric and its components are

$$\begin{aligned} T_{RR} &= \frac{\lambda_R}{\lambda_\Theta} \Sigma_{RR} \cos^2 \psi, & T_{\Theta\Theta} &= \frac{\lambda_\Theta}{\lambda_R} \Sigma_{\Theta\Theta}, & T_{ZZ} &= \frac{\lambda_R}{\lambda_\Theta} \Sigma_{RR} \sin^2 \psi, \\ T_{R\Theta} &= \Sigma_{R\Theta} \cos \psi, & T_{RZ} &= -\frac{\lambda_R}{\lambda_\Theta} \Sigma_{RR} \cos \psi \sin \psi, & T_{\Theta Z} &= -\Sigma_{R\Theta} \sin \psi. \end{aligned} \quad (11)$$

135 At this point, the equilibrium allows us to derive a relationship between applied pressure and deflection
 136 of the membrane. We adopted a semi-inverse approach, with which we set an appropriate kinematics of
 137 deformation and accordingly we obtained the stress tensors. The kinematics of the model is not exact and thus
 138 the local equilibrium equations can not be solved in every internal point of the membrane. The exact solution
 139 to the local equilibrium can not be derived in closed-form and it would include a more general kinematics.
 140 Nevertheless, we derive an analytical solution by imposing the equilibrium between applied pressure and
 141 internal stresses in the neighborhood of the central point of the membrane, which is the most representative
 142 point in this problem. With this aim, we firstly compute the Cauchy stress tensor for the limit case of $R \rightarrow 0$.
 143 In this circumstance, radial and circumferential stretches correspond ($\lambda_R = \lambda_\Theta|_{R \rightarrow 0} = \lambda$). Third invariant I_3
 144 goes to zero and the only non-zero components of the Cauchy stress tensor are

$$T_{RR}|_{R \rightarrow 0} = T_{\Theta\Theta}|_{R \rightarrow 0} = T_0 = \frac{1}{t} \beta_1|_{R \rightarrow 0} + \frac{1}{2t} \left(\psi_0^2 \csc \psi_0^2 - 1 \right) \beta_2|_{R \rightarrow 0}. \quad (12)$$

145 In the neighborhood of the central point, equilibrium along Z direction reads

$$p \left(\pi \rho^2 d\psi^2 \right) = T_0 (2\pi \rho d\psi t) d\psi,$$

146 from which we derive the following relationship between lateral pressure and kinematic parameter ρ :

$$p = \frac{2T_0 t}{\rho}. \quad (13)$$

147 Using (12), (8) and (5) and recalling that $\rho = a/\sin \psi_0$, equation (13) takes the form

$$p = \frac{1}{8a} \sin \psi_0 \sum_{j=1}^4 \kappa_j \left(\psi_0^2 \csc^2 \psi_0 - 1 \right)^j, \quad (14)$$

148 where

$$\kappa_1 = 8(c_2 + 2c_4), \quad \kappa_2 = 12(c_5 + c_6), \quad \kappa_3 = 4(2c_7 + c_8 + 2c_9), \quad \kappa_4 = 5(c_{10} + c_{11} + c_{12}).$$

149 Angle ψ_0 is related to displacement δ of the central node through $\psi_0 = 2 \tan^{-1} \bar{\delta}$, with $\bar{\delta} = \delta/a$ denoting
 150 the normalized deflection. By substitution into (14), the pressure-deflection relation for circular graphene
 151 membranes is finally obtained.

152 2.1 Linear elastic constants of graphene

153 Graphene is isotropic when deformations are small. Hence, in linear elasticity its material behavior is entirely
 154 described by two constants: Young's modulus E and Poisson's ratio ν . Expressions for E and ν can be derived
 155 from the finite theory by introducing the hypothesis that both displacements and displacement gradients are
 156 small [4, 7]. To this aim, strain and stress measures are developed in Taylor series as functions of ψ_0 and they
 157 are truncated at the second order. The Green-Lagrange strain tensor, expressed by (3), assumes the following
 158 linearized expression:

$$[\mathbf{E}] \cong \begin{bmatrix} \frac{\psi_0^2}{6} & 0 & 0 \\ 0 & \frac{(a-R)(a+R)\psi_0^2}{6a^2} & 0 \\ 0 & 0 & 0 \end{bmatrix}. \quad (15)$$

159 Tensor \mathbf{E} in linear elasticity is simply called strain tensor.

160 The linearization of the second Piola-Kirchhoff stress tensor $\mathbf{\Sigma}$, given by (9), provides

$$[\mathbf{\Sigma}] \cong \begin{bmatrix} \frac{\psi_0^2}{6t} \left[\left(1 - \frac{R^2}{a^2}\right) c_2 + 2c_4 \right] & 0 & 0 \\ 0 & \frac{\psi_0^2}{6t} \left[c_2 + 2 \left(1 - \frac{R^2}{a^2}\right) c_4 \right] & 0 \\ 0 & 0 & 0 \end{bmatrix}. \quad (16)$$

161 The development in Taylor series of both \mathbf{T}_R and \mathbf{T} (equations (11) and (10) respectively), with truncation at
 162 the second order in ψ_0 , gives the same result as (16). Therefore, as it should be, in the linearized theory all
 163 the stress measures coincide and we may refer only to a single stress tensor, expressed by (16). Furthermore,
 164 we notice that the representation of the stress tensor in the principal strain system is diagonal. This indicates
 165 that in the linearized theory principal strain and stress directions coincide. This because graphene is isotropic
 166 for small deformations.

167 The Navier's constitutive relationships for plane stress are

$$\begin{aligned} \sigma_R &= \frac{E}{1-\nu^2} (\epsilon_R + \nu\epsilon_\Theta), \\ \sigma_\Theta &= \frac{E}{1-\nu^2} (\epsilon_\Theta + \nu\epsilon_R). \end{aligned} \quad (17)$$

168 Stress components σ_R and σ_Θ are given respectively by the radial and circumferential components of the
 169 linearized stress tensor (16). Same goes for strain components ϵ_R and ϵ_Θ , which are expressed by the strain
 170 tensor (15). Equation (17) transforms into the following linear system of two equations in the two unknown
 171 variables E and ν :

$$\begin{aligned} \frac{8a^2c_4 + 4c_2(a-R)(a+R)}{t} + \frac{E [4a^2(\nu+1) - 4\nu R^2]}{\nu^2 - 1} &= 0, \\ \frac{4a^2c_2 + 8c_4(a-R)(a+R)}{t} + \frac{E [4a^2(\nu+1) - 4R^2]}{\nu^2 - 1} &= 0, \end{aligned}$$

172 whose solution gives the expressions of the elastic constants of graphene in linear elasticity

$$E = \frac{1}{t} \left(2c_4 - \frac{c_2^2}{2c_4} \right), \quad \nu = \frac{c_2}{2c_4}. \quad (18)$$

173 This result corresponds to that derived by Höller et al. [11]. Under the hypothesis of homogeneous deformations,
 174 the authors obtained the expression of the tangent elasticity tensor. The linearization of such tensor with $\mathbf{E} \rightarrow \mathbf{0}$
 175 provided the Young's modulus and Poisson's ratio given in (18).

176 3 Finite element simulation

177 The FE model was realized by using software COMSOL Multiphysics version 6.0 [25]. The 3D membrane
 178 interface of the structural mechanics module was selected. This interface allows to model plane stress elements
 179 without bending stiffness that can deform both in the in-plane and out-of-plane directions.

180 The geometry of the membrane was defined through a work plane, in which a circle with radius $a = 2.375$
 181 μm was built. This value of a is the one considered in the experimental and numerical investigations of
 182 works [13, 16, 40]. We will present comparisons of the results in the next section. The thickness of the membrane
 183 was set to $t = 0.335$ nm. A fixed constraint was assigned along the perimeter. This reproduces the condition for
 184 which, along the constrained geometry, displacements are zero in all directions. A pressure load was applied
 185 to the free face of the membrane. The pressure load is a follower load, therefore its direction changes with
 186 deformation in the geometrically nonlinear analysis.

187 In the COMSOL membrane analysis it is necessary to apply a tensile prestress. This in order to avoid
 188 the singularity due to the fact that the undeformed membrane has no transverse stiffness. In our model, the
 189 prestress was introduced as an external in-plane force of 0.001 N/m, which is negligible compared to the stress
 190 values acting in the graphene membrane during the simulation. The sole scope of the prestress was to avoid
 191 the singularity and allow the solver to find a solution.

192 The material behavior was defined through the user-defined compressible hyperelastic material. In detail,
 193 the isotropic invariants were introduced as local variables according to (4). Anisotropy was added by sub-
 194 dividing the domain into subdomains. To do this, the membrane was cut by planes parallel to direction z
 195 and containing central point O . Starting from direction x , a plane was defined for every angle increment of 5
 196 degrees (see Fig. 3a). The entire domain was thus partitioned into 72 subdomains. In each of them, invariant I_3
 197 was defined as a local variable with the corresponding value of $\cos(6\phi)$. In other words, the variation of term
 198 $\cos(6\phi)$ in the expression of I_3 was introduced in a discrete way by subdividing the membrane domain into
 199 several subdomains. It goes without saying that this is a simplification, but it gives a reasonable approximation
 200 of the continuous variation of I_3 as a function of ϕ . One may further subdivide the domain in order to reach
 201 more accuracy, but as we will see in the following the contribution of graphene anisotropy is negligible in the
 202 problem analyzed. The subdivision into 72 subdomains is already enough.

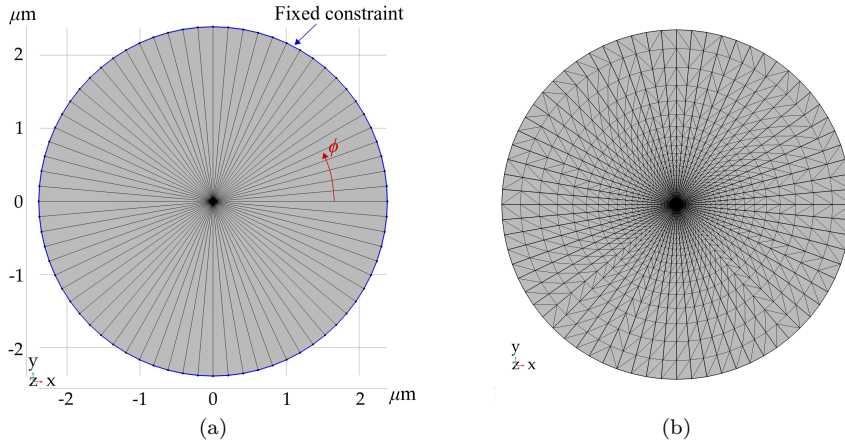

Fig. 3: FE simulation: (a) subdivided domain to define the anisotropic material properties of graphene and (b) mesh used for the analysis.

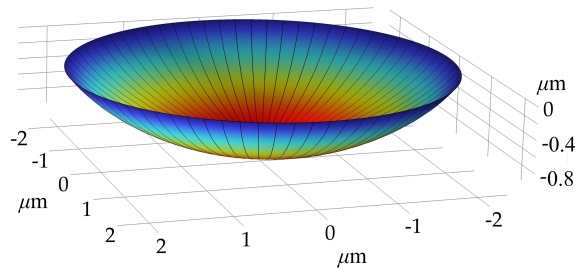

Fig. 4: Deformed configuration of the circular graphene membrane during the FE simulation.

203 The mesh was composed of triangular elements with minimum and maximum size of, respectively, 0.019
 204 and $0.26 \mu\text{m}$ (Fig. 3b). A stationary simulation was carried out and the applied pressure was increased from 5
 205 Pa to 17 MPa. The stationary solver MUMPS was employed. The simulation stopped when a stationary value
 206 for the pressure was reached and thus, for further increasing values, convergence was not found anymore. Fig.
 207 4 shows the deformed configuration of the circular graphene membrane for a certain value of applied pressure.
 208

209 4 Results and comparison

210 In this section we put in comparison the results of the analytical model and the FE simulation. Note that in
 211 the FE software it is not possible to develop a 3D membrane model with no dependence on the transverse
 212 deformation. Therefore, the FE simulation takes into account the contraction of the membrane, which means
 213 that λ_Z may assume values other than 1. This is in contrast with the assumption of the analytical model,
 214 according to which the graphene membrane can not undergo transverse contraction. Hence, to provide a
 215 consistent comparison, we derive the analytical solution by introducing λ_Z in the equilibrium problem. The
 216 derivation of such solution is given in Appendix A. It is stressed that this solution has the sole scope of
 217 comparison with the FE simulation and thus validation of the model. The reference analytical solution remains

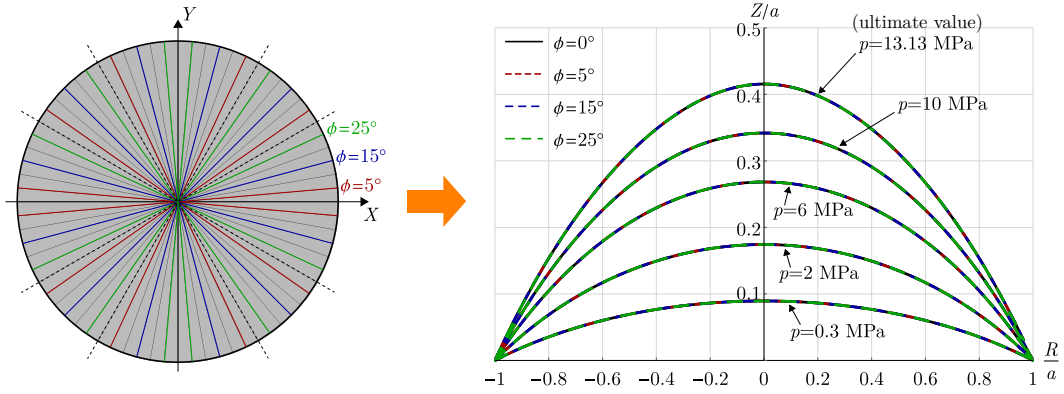

Fig. 5: Profiles of deformation from the FE simulation represented in the R - Z plane and given in terms of dimensionless coordinates R/a and Z/a ($a = 2.375 \mu\text{m}$). The deformed shapes along diameters with different angle ϕ coincide and therefore the kinematics of deformation is axisymmetric.

218 the one derived in Section 2, which is more consistent with reality. After validating the model, a comparison
 219 with other results from experimental data and numerical simulations is presented.

220 4.1 Validation of the model

221 The analytical model is based on the assumption that the kinematics of deformation maintains its rotational
 222 symmetry throughout the deformation process caused by the application of lateral pressure. This assumption
 223 is valid for isotropic materials, but in general not for anisotropic materials. However, due to the particular
 224 form of anisotropic invariant I_3 , anisotropy of graphene plays a role only when deformations are large enough
 225 and the principal stretches do not coincide. For instance, anisotropy of graphene does not activate when it is
 226 subjected to equibiaxial loads.

227 In our problem, the difference between stretches λ_R and λ_Θ is not large enough to activate anisotropy
 228 of graphene. This is demonstrated by Fig. 5, which shows the profiles of deformation along diameters of the
 229 membrane identified by different angles ϕ . We observe that variations of ϕ do not cause appreciable variations
 230 in the deformed shape, represented in the R - Z plane. This means that the three-dimensional deformed con-
 231 figuration is axisymmetric with respect to Z . Further confirmation of this is given by Fig. 6a, which shows
 232 normalized displacement u_Z/a in the X - Y plane for the ultimate value of pressure computed during the FE
 233 simulation. It is clearly visible that u_Z is axisymmetric. In addition, Fig. 6b shows the trend of invariant I_3
 234 in the membrane domain. Its values are very close to zero in the entire domain, except from the areas close
 235 to the perimeter. This because in such areas, due to the influence of the constrained boundary, stretches λ_R
 236 and λ_Θ differ more than in the inner region. Nevertheless, the values assumed by I_3 are largely negligible with
 237 respect to the other deformation quantities and therefore anisotropy of graphene does not play a noticeable
 238 role. The above discussion demonstrates that the assumption of rotational symmetry in the analytical model
 239 is accurate and in accordance with the FE simulation.

240 We now focus on the comparison of the pressure-deflection curves, which is reported in Fig. 7. Both
 241 analytical models with and without transverse contraction are represented. The accuracy of the analytical

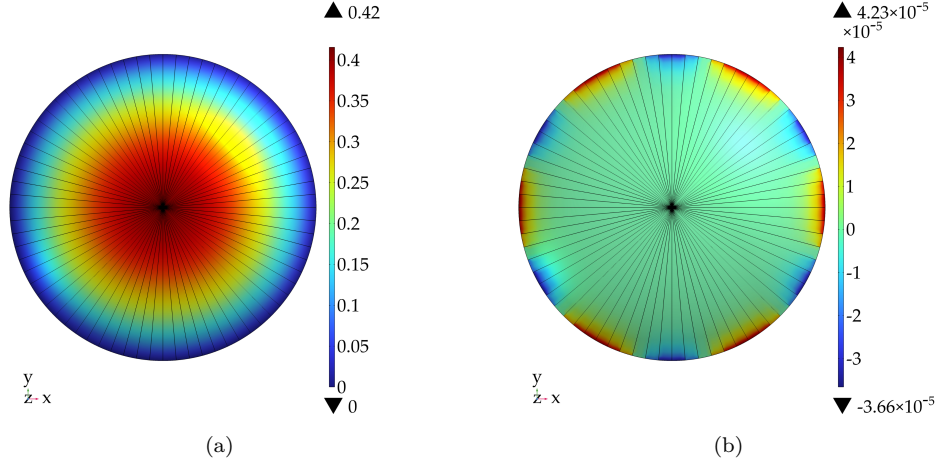

Fig. 6: (a) Normalized deflection u_z/a and (b) invariant I_3 at the ultimate value of pressure from the FE simulation. The values of I_3 are negligible and thus anisotropy of graphene does not activate.

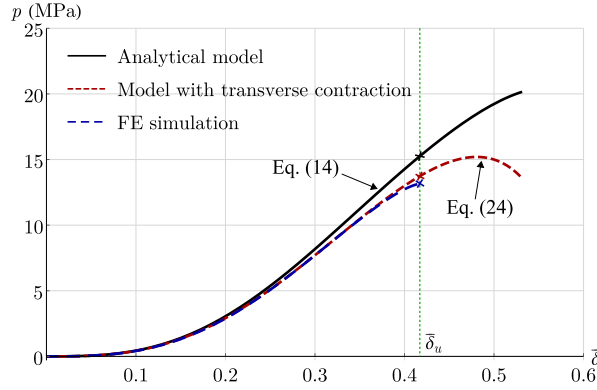

Fig. 7: Pressure-deflection curves with $\bar{\delta} = \delta/a$ of a circular graphene sheet with radius $2.375 \mu\text{m}$. Black and red curves represent respectively the analytical models with and without transverse contraction, while the blue curve is the FE simulation.

242 model is demonstrated by the good agreement between FE simulation and analytical model with transverse
 243 contraction, expressed by Eq. (14). The two pressure-deflection curves match until $\bar{\delta}$ assumes values greater
 244 than 0.4. Afterwards, the curve from the FE model is less stiff and the simulation ended as soon as the
 245 stationary value of pressure was reached. This discrepancy is explained by observing the comparison of the
 246 deformation profiles given in Fig. 8. The analytical and FE deformed configurations almost coincide for $\bar{\delta} \leq 0.4$,
 247 but then the membrane in the FE model experienced a higher deformation concentrated in the area close to
 248 the center. This produced a reduction of the stiffness and a rapid attainment of the ultimate value of pressure
 249 $p_u = 13.13 \text{ MPa}$. The ultimate value of stretch at the pole in the FE simulation is $\lambda_u = 1.17$, which corresponds
 250 to the ultimate normalized displacement $\bar{\delta}_u = 0.42$.

251 In light of the above considerations, the analytical model proposed in this work can be considered very
 252 accurate. The hypothesis on the kinematics of deformation generates some discrepancies in the pressure-
 253 deflection curve only when the system is close to the ultimate configuration. The value of pressure at $\bar{\delta}_u$
 254 predicted by the model is 13.67 MPa and the relative error with respect to the FE prediction is 4% , which is

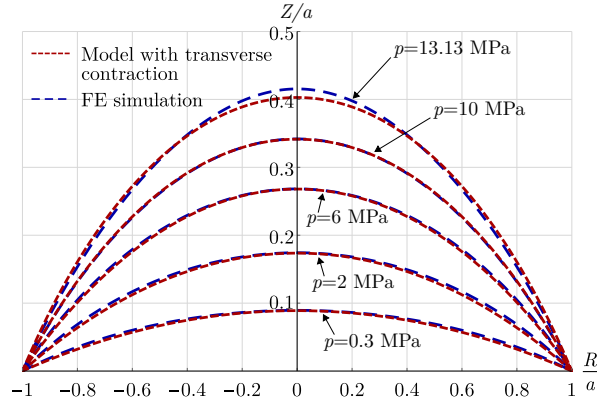

Fig. 8: Profiles of deformation from analytical model (with transverse contraction) and FE simulation represented in the R - Z plane and given in terms of dimensionless coordinates R/a and Z/a .

255 largely acceptable. The analytical model should be applied by assuming as ultimate displacement $\bar{\delta}_u = 0.42$,
 256 which comes from the FE prediction.

257 We recall that the model with transverse contraction described in Appendix A was introduced with the
 258 sole purpose of comparison with the FE simulation and consequent validation. As already pointed out, the
 259 model that is most consistent with the real response of graphene is the one without transverse contraction,
 260 expressed by relation (14). The pressure-deflection curve given by such model is depicted in Fig. 7. As expected,
 261 the fact that graphene can not deform along its thickness makes its response sensibly stiffer, especially when
 262 deformations become moderately large. Indeed, the ultimate pressure value is 15.16 MPa, with an increment
 263 of 15% with respect to the FE prediction, which includes transverse contraction of the membrane. In light of
 264 this, FE simulations of graphene subjected to large deformations should be carried out carefully, reminding
 265 that the response might be sensibly underestimated.

266 In the following we present a comparison with other results from the literature. In light of the above
 267 discussion, from now on the reference analytical model is the one without transverse contraction.

268 4.2 Comparison with other results

269 The results are now put in comparison with other models, numerical simulations and experiments found in
 270 the literature. The well-known Fitcher's model [6] is considered and, for the sake of brevity, it is outlined
 271 in Appendix B. The experimental data that we consider are reported in the work by Koenig et al. [16]. In
 272 that work, the authors produced monolayer graphene sheets through mechanical exfoliation over predefined
 273 microcavities etched in a silica substrate. The microcavities had diameter of around $4.75 \mu\text{m}$. A bulge test
 274 was performed using a pressure chamber and the deformed shape of the graphene membrane was measured
 275 with an atomic force microscope. For the comparison we also consider the FE simulation carried out by Jiang
 276 et al. [13]. The FE model was built in software COMSOL Multiphysics using a plate element composed of
 277 linearly elastic and isotropic material. The circular plate had diameter of $4.75 \mu\text{m}$ and it was clamped along
 278 the boundary. Geometric nonlinearity was included in the solution.

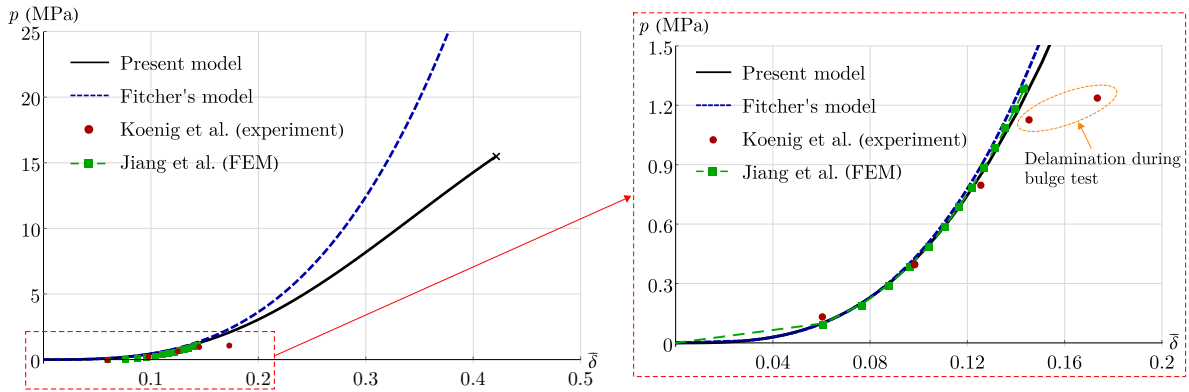

Fig. 9: Comparison of the pressure-deflection curves obtained with the proposed model, Fitcher's model [6], experiment from Koenig et al. [16] and FE simulation carried out by Jiang et al. [13] for a graphene membrane with diameter $4.75 \mu\text{m}$.

279 Figure 9 shows the comparison of the pressure-deflection curves. The black curve (present model) is ex-
 280 pressed by equation (14). The Fitcher's solution is in good agreement with our model only for small values of
 281 $\bar{\delta}$. This because Fitcher's model is based on the assumption of linear elastic material. Such assumption is not
 282 suitable for graphene, which exhibits material nonlinearity even for relatively small values of strain [10, 23]. In
 283 particular, the uniaxial stress-strain response of graphene shows a progressive reduction of its stiffness until
 284 the attainment of the ultimate stress. This is not taken into account in Fitcher's model and the result is that,
 285 as the strain increases, the gap between its prediction and our model increases. Fitcher's model is always stiffer
 286 because it does not include the stiffness reduction of graphene due to nonlinearity.

287 From the right side of Fig. 9 we observe a good agreement of our model with the experimental data
 288 by Koenig et al. [16]. However, at some point of the experiment a delamination of graphene from the silica
 289 substrate took place. This explains why the last two experimental data (red dots) deviate from the analytical
 290 prediction. Very good agreement is found also with the FE simulation of Jiang et al. [13]. Note that their
 291 simulation was based on the assumption of linear elastic material. In fact, when $\bar{\delta}$ exceeds 0.12 their prediction
 292 becomes slightly stiffer than the response of our model.

293 Further comparisons are presented in Fig. 10. In particular, in Fig. 10a we consider the FE simulation
 294 carried out by Wang et al. [40] using software ANSYS. The authors used 2-node axisymmetric shell elements
 295 composed of a linear elastic material with $E = 1 \text{ TPa}$ and $\nu = 0.17$. As expected, for the same reasons
 296 explained previously, the FE simulation matches well with our model only for relatively small deflections. It
 297 is demonstrated once again that the material nonlinearity of graphene plays an important role and must be
 298 considered.

299 Fig. 10b shows a comparison with the molecular dynamics (MD) simulation carried out by Wang et
 300 al. [42], which is displayed in green color. The graphene membrane had diameter 10 nm. The choice of such
 301 a small diameter is due to the fact that MD simulations require a large computational effort and therefore
 302 they can be applied only to systems with a relatively small number of atoms. Although the computational
 303 strategy is different from the continuum modeling, the simulation is in good agreement with the present

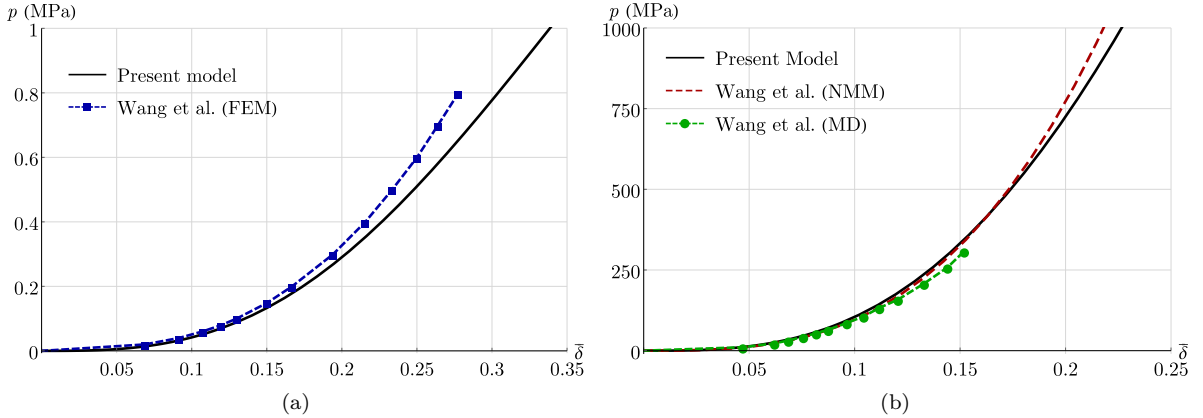

Fig. 10: Comparison with (a) FE simulation of a graphene sheet with diameter $50 \mu\text{m}$, reported in Wang et al. [40], and (b) nonlinear membrane model (NMM) and molecular dynamics (MD) simulation of a graphene sheet with diameter 10 nm , reported in Wang et al. [42].

304 model. The gap is mainly due to the parametrization of the interatomic potential describing the carbon-
 305 carbon interactions in graphene. Wang et al. [42] adopted the second-generation reactive empirical bond-order
 306 (REBO-2) potential [1], but there are several potentials that can be used and may lead to sensibly different
 307 results [8, 9, 26]. The coefficients of the stored energy function (6) adopted in this work were estimated by
 308 fitting molecular mechanics simulations based on the modified Morse potential [28], which is considered the
 309 most reliable for describing the carbon-carbon interactions in graphene.

310 A nonlinear membrane model (NMM) was also proposed by Wang et al. [42] (equations (3.4) and (3.5)
 311 in [42]). The corresponding response of the pressurized graphene membrane is depicted in Fig. 10b. We observe
 312 again a good match with our analytical prediction for relatively small deflections. The model proposed in [42]
 313 does not take into account material nonlinearity and thus it deviates from our model as the deflection increases.

314 5 Conclusions

315 In the present work we analyzed the problem of circular graphene membranes subjected to uniform lateral
 316 pressure. The analytical formulation was developed in finite elasticity, considering both material and geometric
 317 nonlinearities. The kinematics of deformation was described by assuming that the membrane preserves the
 318 axisymmetry and deforms into a spherical cap. Such assumptions are accurate up to moderately large strains
 319 and therefore are suitable to describe the behavior of graphene, which reaches failure for uniaxial elongations
 320 of around 15-20%.

321 The material behavior was described by a hyperelastic stored energy function that takes into account both
 322 nonlinearity and anisotropy of graphene. The isotropicization theorem allowed us to derive the Piola-Kirchhoff
 323 and Cauchy stress tensors. The equilibrium for $R \rightarrow 0$ was written and an expression of the applied pressure
 324 as a function of the deflection of the membrane was derived.

325 A FE model was built in software COMSOL Multiphysics using the 3D membrane interface. Both material
 326 nonlinearity and anisotropy of graphene were included. It was shown that for circular pressurized graphene

327 membranes the effect of material anisotropy is negligible and thus the deformed configuration remains ax-
 328 isymmetric. Furthermore, it was demonstrated that a spherical cap provides an accurate description of the
 329 kinematics of deformation. The hypotheses of the analytical formulation proposed in this work were thus
 330 validated. The results of the simulation were in good agreement with the prediction of the analytical model.

331 We presented a comparison with other models, numerical simulations and experiments found in the lit-
 332 erature. Good agreement in the pressure-deflection curves was found only for relatively small deflections.
 333 This because, differently from our entirely nonlinear approach, all the continuum models in the literature are
 334 based on the assumption of linear elastic material. This emphasizes the novelty of the present work and the
 335 advantages of the proposed model.

336 The model is an effective and useful tool for an accurate prediction of the response of pressurized graphene
 337 membranes. For the first time, a pressure-deflection relation in nonlinear elasticity was proposed. This is
 338 a great advantage in terms of applicability because it does not require any computational effort, which is
 339 the main concern in atomistic and FE simulations. Moreover, it is not easy to define the nonlinear material
 340 behavior of graphene in FE models. In addition, FE models in finite elasticity include transverse contraction,
 341 which is not present in the real behavior of a single layer graphene sheet. It was shown that this leads to an
 342 underestimation of the response of the membrane, especially when deformations become relatively large.

343 Acknowledgments

344 This work was supported by the Italian Ministry of University and Research (MUR) through research grant
 345 PRIN 2020 No. 2020EBLPLS on “Opportunities and challenges of nanotechnology in advanced and green
 346 construction materials” and through project FISR 2019: “Eco Earth” (code 00245). Financial support by the
 347 National Group of Mathematical Physics (GNFM-INdAM) is also acknowledged.

348 Compliance with Ethical Standards

349 Conflict of Interest: The authors declare that they have no conflict of interest.

350 A Analytical solution with transverse contraction

351 After deformation, thickness t transforms into $t' = \lambda_Z t$. This transverse contraction is introduced by defining the deformation
 352 gradient as follows:

$$[\mathbf{F}] = \begin{bmatrix} \rho \frac{\partial \psi}{\partial R} \cos \psi & 0 & \lambda_Z \sin \psi \\ 0 & \frac{\rho \sin \psi}{R} & 0 \\ -\rho \frac{\partial \psi}{\partial R} \sin \psi & 0 & \lambda_Z \cos \psi \end{bmatrix}.$$

353 Rotation tensor \mathbf{R} remains unchanged and pure deformation tensor \mathbf{U} becomes

$$[\mathbf{U}] = \begin{bmatrix} \rho \frac{\partial \psi}{\partial R} & 0 & 0 \\ 0 & \frac{\rho \sin \psi}{R} & 0 \\ 0 & 0 & \lambda_Z \end{bmatrix}.$$

354 The right Cauchy-Green deformation tensor and the Green-Lagrange strain tensor expressed in cylindrical coordinates
355 assume the form

$$[\mathbf{C}] = \begin{bmatrix} \lambda_R^2 & 0 & 0 \\ 0 & \lambda_\Theta^2 & 0 \\ 0 & 0 & \lambda_Z^2 \end{bmatrix}, \quad [\mathbf{E}] = \frac{1}{2} \begin{bmatrix} \lambda_R^2 - 1 & 0 & 0 \\ 0 & \lambda_\Theta^2 - 1 & 0 \\ 0 & 0 & \lambda_Z^2 - 1 \end{bmatrix},$$

356 where λ_R and λ_Θ are given by (2).

357 Strain invariants I_1 and I_2 become

$$\begin{aligned} I_1 &= \frac{1}{2} (\lambda_R^2 + \lambda_\Theta^2 + \lambda_Z^2 - 3), \\ I_2 &= \frac{1}{4} (\lambda_R^2 - 1) (\lambda_\Theta^2 - 1) + \frac{1}{4} (\lambda_R^2 - 1) (\lambda_Z^2 - 1) + \frac{1}{4} (\lambda_\Theta^2 - 1) (\lambda_Z^2 - 1), \end{aligned} \quad (19)$$

358 while invariant I_3 has the same expression as in (5). The second Piola-Kirchhoff stress tensor is computed using (7),
359 obtaining

$$\begin{aligned} \Sigma_{RR} &= \frac{\beta_1}{t} + \frac{\beta_2}{2t} (\lambda_R^2 - 1) + \frac{3\beta_3}{4t} (\lambda_R^2 - \lambda_\Theta^2)^2 \cos(6\phi), \\ \Sigma_{\Theta\Theta} &= \frac{\beta_1}{t} + \frac{\beta_2}{2t} (\lambda_\Theta^2 - 1) - \frac{3\beta_3}{4t} (\lambda_R^2 - \lambda_\Theta^2)^2 \cos(6\phi), \\ \Sigma_{ZZ} &= \frac{\beta_1}{t} + \frac{\beta_2}{2t} (\lambda_Z^2 - 1), \\ \Sigma_{R\Theta} &= -\frac{3\beta_3}{4t} (\lambda_R^2 - \lambda_\Theta^2)^2 \sin(6\phi), \quad \Sigma_{RZ} = \Sigma_{\Theta Z} = 0, \end{aligned} \quad (20)$$

360 where β_1 , β_2 and β_3 are given in (8). The first Piola-Kirchhoff stress tensor is thus derived

$$[\mathbf{T}_R] = \begin{bmatrix} \lambda_R \Sigma_{RR} \cos \psi & \lambda_R \Sigma_{R\Theta} \cos \psi & \lambda_Z \Sigma_{ZZ} \sin \psi \\ \lambda_\Theta \Sigma_{R\Theta} & \lambda_\Theta \Sigma_{\Theta\Theta} & 0 \\ -\lambda_R \Sigma_{RR} \sin \psi & -\lambda_R \Sigma_{R\Theta} \sin \psi & \lambda_Z \Sigma_{ZZ} \cos \psi \end{bmatrix}.$$

361 Boundary conditions $\pm \mathbf{T}_R \mathbf{n}_Z = \mathbf{0}$ require that

$$\lambda_Z \Sigma_{ZZ} \sin \psi = 0 \quad \text{and} \quad \lambda_Z \Sigma_{ZZ} \cos \psi = 0, \quad \forall \psi \in [0, \pi/6], \quad (21)$$

362 which are satisfied only if $\Sigma_{ZZ} = 0$. From this condition and recalling (20), we derive the following implicit expression of
363 stretch λ_Z :

$$\lambda_Z = \sqrt{1 - 2 \frac{\beta_1}{\beta_2}}. \quad (22)$$

364 Finally, the components of the Cauchy stress tensor read

$$\begin{aligned} T_{RR} &= \frac{\lambda_R}{\lambda_\Theta \lambda_Z} \Sigma_{RR} \cos^2 \psi, & T_{\Theta\Theta} &= \frac{\lambda_\Theta}{\lambda_R \lambda_Z} \Sigma_{\Theta\Theta}, & T_{ZZ} &= \frac{\lambda_R}{\lambda_\Theta \lambda_Z} \Sigma_{RR} \sin^2 \psi, \\ T_{R\Theta} &= \frac{1}{\lambda_Z} \Sigma_{R\Theta} \cos \psi, & T_{RZ} &= -\frac{\lambda_R}{\lambda_\Theta \lambda_Z} \Sigma_{RR} \cos \psi \sin \psi, & T_{\Theta Z} &= -\frac{1}{\lambda_Z} \Sigma_{R\Theta} \sin \psi, \end{aligned}$$

365 with λ_Z expressed by (22).

366 As we did in Section 2, we now write the equilibrium in the neighborhood of the central point of the membrane. With
367 this aim, we firstly compute the Cauchy stress tensor for the limit case of $R \rightarrow 0$. Radial and circumferential stretches
368 correspond ($\lambda_R = \lambda_\Theta|_{R \rightarrow 0} = \lambda$) and third invariant I_3 goes to zero. The only non-zero components of the Cauchy stress

369 tensor are

$$T_{RR}|_{R \rightarrow 0} = T_{\Theta\Theta}|_{R \rightarrow 0} = T_0 = \frac{\psi_0^2 \csc \psi_0^2 - \lambda_Z^2|_{R \rightarrow 0}}{2t \lambda_Z|_{R \rightarrow 0}} \beta_2|_{R \rightarrow 0}. \quad (23)$$

370 Hereinafter, for the sake of simplicity, we indicate $\lambda_Z|_{R \rightarrow 0}$ simply with λ_Z . Equilibrium equation (13) becomes

$$p = \frac{2T_0 \lambda_Z t}{\rho},$$

371 from which, using (23), (8) and (19), we derive the following expression of the applied pressure:

$$p = \frac{\sin \psi_0}{8a} \left(\psi_0^2 \csc^2 \psi_0 - \lambda_Z^2 \right) \sum_{j=0}^3 \zeta_j \psi_0^{2j} \csc^{2j} \psi_0, \quad (24)$$

372 where

$$\begin{aligned} \zeta_0 &= \lambda_Z^2 \left[\lambda_Z^2 \left(5c_{10} \lambda_Z^2 - c_{11} \lambda_Z^2 - 25c_{10} - 3c_{11} + 4c_{12} \right) + 8c_7 \left(\lambda_Z^2 - 4 \right) - 2c_9 \left(\lambda_Z^2 + 2 \right) - 4c_6 + 8c_8 + 9 \left(5c_{10} + 3c_{11} - 2c_{12} \right) \right. \\ &\quad \left. + 12c_5 \left(\lambda_Z^2 - 3 \right) - 8c_2 + 16c_4 + 3 \left(4c_6 + 16c_7 - 4c_8 + 2c_9 - 15c_{10} - 9c_{11} + 6c_{12} \right), \right. \\ \zeta_1 &= 2\lambda_Z^2 \left[3c_{11} \left(\lambda_Z^2 - 8 \right) - 2c_{12} \left(\lambda_Z^2 - 7 \right) + 5c_{10} \left(\lambda_Z^2 - 4 \right) - 4c_8 + 4c_9 \right] + 16c_7 \left(\lambda_Z^2 - 4 \right) \\ &\quad + 24c_5 - 8c_6 + 16c_8 - 8c_9 + 90c_{10} + 54c_{11} - 36c_{12}, \\ \zeta_2 &= 2 \left[c_{12} \left(11 - 5\lambda_Z^2 \right) + 5c_{10} \left(\lambda_Z^2 - 7 \right) + 3c_{11} \left(3\lambda_Z^2 - 5 \right) + 12c_7 - 2c_8 \right], \\ \zeta_3 &= 4 \left(5c_{10} + c_{11} - c_{12} \right). \end{aligned}$$

373 An explicit expression of stretch λ_Z is derived by satisfying condition (21) for the limit case of $R \rightarrow 0$, for which $\lambda_R =$
374 $\lambda_{\Theta}|_{R \rightarrow 0} = \lambda$. In this case, substitution of (8) and (19) into (22) gives

$$\sqrt{\eta} - \sqrt{\frac{\Delta_n}{\Delta_d}} = 0, \quad (25)$$

375 with $\eta = \lambda_Z^2$ and

$$\begin{aligned} \Delta_n &= -8c_2 \left(\eta + 2\lambda^2 - 2 \right) + 16c_4 + 12c_5 \left[-\eta + 2 \left(\eta - 1 \right) \lambda^2 + \lambda^4 \right] - 4c_6 \left[\eta^2 - 7\eta + 2 \left(3\eta - 7 \right) \lambda^2 + 5\lambda^4 + 9 \right] \\ &\quad + 8c_7 \left[-\eta^2 + 5\eta + \left(5\eta - 8 \right) \lambda^4 + 2 \left(\eta - 5 \right) \left(\eta - 1 \right) \lambda^2 + 2\lambda^6 - 3 \right] - 4c_8 \left(\lambda - 1 \right) \left(\lambda + 1 \right) \left(2\eta + \lambda^2 - 3 \right) \left(\eta + 2\lambda^2 - 2 \right) \\ &\quad - 2c_9 \left[\eta^3 - 4\eta^2 + 11\eta + 2 \left(\eta - 7 \right) \lambda^4 + 2 \left(\eta^2 - 6\eta + 11 \right) \lambda^2 + 4\lambda^6 - 12 \right] \\ &\quad + 5c_{10} \left\{ -\eta^3 + 6\eta^2 - 15\eta + 8 \left(\eta - 2 \right) \lambda^6 + \left[\eta \left(5\eta - 32 \right) + 33 \right] \lambda^4 + 2 \left(\eta - 1 \right) \left[\left(\eta - 6 \right) \eta + 15 \right] \lambda^2 + 3\lambda^8 + 9 \right\} \\ &\quad - c_{11} \left\{ \eta \left[\left(\eta - 5 \right) \eta^2 + 9 \right] + 8 \left(1 - 2\eta \right) \lambda^6 - 3 \left[5 \left(\eta - 4 \right) \eta + 9 \right] \lambda^4 + 2 \left[\eta \left(\eta^2 + 9\eta - 27 \right) + 9 \right] \lambda^2 + \lambda^8 \right\} \\ &\quad - c_{12} \left(\lambda - 1 \right) \left(\lambda + 1 \right) \left(2\eta + \lambda^2 - 3 \right) \left[2 \left(\eta - 6 \right) \eta + 10\eta\lambda^2 + 9\lambda^4 - 24\lambda^2 + 15 \right], \\ \Delta_d &= -8c_2 + 16c_4 + 12c_5 \left(\eta + 2\lambda^2 - 3 \right) - 4c_6 \left(\eta + 2\lambda^2 - 3 \right) + 8c_7 \left[\eta^2 + 2 \left(\eta - 4 \right) \lambda^2 - 4\eta + 3\lambda^4 + 6 \right] \\ &\quad - 4c_8 \left(\lambda^2 - 1 \right) \left(2\eta + \lambda^2 - 3 \right) - 2c_9 \left(\eta - 1 \right) \left(\eta - 4\lambda^2 + 3 \right) + 5c_{10} \left(\eta + 2\lambda^2 - 3 \right) \left[\left(\eta - 2 \right) \eta + 2\lambda^4 - 4\lambda^2 + 3 \right] \\ &\quad - c_{11} \left(\eta + 2\lambda^2 - 3 \right) \left[\eta^2 + 4 \left(3 - 2\eta \right) \lambda^2 + 6\eta - 2\lambda^4 - 9 \right] - 2c_{12} \left(\lambda - 1 \right) \left(\lambda + 1 \right) \left(2\eta + \lambda^2 - 3 \right) \left(\eta + 2\lambda^2 - 3 \right). \end{aligned}$$

376 Equation (25) admits four solutions in η . Two solutions are not real and another one does not respect condition $\eta = 1$
377 when $\lambda = 1$. The remaining solution is the correct one. We do not report this solution due to its very long mathematical
378 expression. Having obtained an explicit expression for η , we compute $\lambda_Z = \sqrt{\eta}$ and by substitution into (24) we finally
379 derive the pressure-deflection equation. We recall that relation $\psi_0 = 2 \tan^{-1} \bar{\delta}$ allows us to obtain a direct expression of
380 pressure as a function of deflection.

381 B Fitcher's model

382 Fitcher's model is based on the assumption that the material is linearly elastic. In this case, the equilibrium equations are

$$\begin{aligned}
 N^2 \left(\bar{R}^2 \frac{d^2 N}{d\bar{R}^2} + 3\bar{R} \frac{dN}{d\bar{R}} \right) - \frac{1}{2} \bar{R}^3 \frac{dN}{d\bar{R}} + \frac{1}{2} (3 + \nu) \bar{R}^2 N + \frac{1}{4} \frac{\bar{R}^2 E H}{\rho L} &= 0, \\
 N \frac{d\bar{\delta}}{d\bar{R}} + \frac{1}{2} \bar{R} &= 0,
 \end{aligned}
 \tag{26}$$

383 where $\bar{R} = R/a$, E is the Young's modulus, ν is the Poisson's ratio and $N = N_R/(pa)$, with N_R indicating the radial
 384 stress resultant. Young's modulus and Poisson's ratio of graphene are computed using (18), obtaining $E = 1042.9$ GPa and
 385 $\nu = 0.146$. The solution for both stress resultant and deflection is found in the form of a power series

$$\begin{aligned}
 N(\bar{R}) &= \sum_0^{\infty} n_{2m} \bar{R}^{2m}, \\
 \bar{\delta}(\bar{R}) &= \sum_0^{\infty} w_{2n} (1 - \bar{R}^{2n+2}).
 \end{aligned}
 \tag{27}$$

386 Substituting (27)₁ into (26)₁ and equating coefficients of like powers of \bar{R} we obtain a system of equations that allows to
 387 derive the expressions of coefficients n_{2m} as functions of n_0 . Likewise, substituting (27)₂ into (26)₂ and equating coefficients
 388 of like powers of \bar{R} we derive the expressions of coefficients w_{2n} as functions of n_0 . Finally, n_0 is evaluated by imposing the
 389 following boundary condition on radial displacement:

$$\left\{ \bar{R} \left[\frac{d}{d\bar{R}} (\bar{R}N) - \nu N - \bar{R} \frac{d\bar{\delta}}{d\bar{R}} \right] \right\} \Big|_{\bar{R}=1} = 0.$$

390 This procedure was implemented in software Wolfram Mathematica. A vector of increasing pressure values was defined
 391 and, for each value, the solution was obtained by considering twelve terms in the power series ($m = 12$ and $n = 12$). More
 392 terms did not cause sensible variations in the solutions and only increased the computational burden.

References

1. Brenner, D.W., Shenderova, O.A., Harrison, J.A., Stuart, S.J., Ni, B., Sinnott, S.B.: A second-generation reactive empirical bond order (REBO) potential energy expression for hydrocarbons. *Journal of Physics: Condensed Matter* **14**(4), 783 (2002)
2. Bunch, J.S., Verbridge, S.S., Alden, J.S., Van Der Zande, A.M., Parpia, J.M., Craighead, H.G., McEuen, P.L.: Impermeable atomic membranes from graphene sheets. *Nano letters* **8**(8), 2458–2462 (2008)
3. Caillerie, D., Mourad, A., Raouf, A.: Discrete homogenization in graphene sheet modeling. *Journal of Elasticity* **84**(1), 33–68 (2006)
4. Casey, J.: On infinitesimal deformation measures. *Journal of Elasticity* **28**(3), 257–269 (1992)
5. Fang, M., Wang, K., Lu, H., Yang, Y., Nutt, S.: Covalent polymer functionalization of graphene nanosheets and mechanical properties of composites. *Journal of Materials Chemistry* **19**(38), 7098–7105 (2009)
6. Fichter, W.B.: Some solutions for the large deflections of uniformly loaded circular membranes, vol. 3658. National Aeronautics and Space Administration, Langley Research Center (1997)
7. Freddi, F., Royer-Carfagnani, G.: From non-linear elasticity to linearized theory: examples defying intuition. *Journal of Elasticity* **96**(1), 1–26 (2009)
8. Genoese, A., Genoese, A., Rizzi, N.L., Salerno, G.: On the derivation of the elastic properties of lattice nanostructures: the case of graphene sheets. *Composites Part B: Engineering* **115**, 316–329 (2017)
9. Genoese, A., Genoese, A., Salerno, G.: In-plane and out-of-plane tensile behaviour of single-layer graphene sheets: a new interatomic potential. *Acta Mechanica* **231**(7), 2915–2930 (2020)
10. Georgantzinos, S.K., Katsareas, D.E., Anifantis, N.K.: Graphene characterization: A fully non-linear spring-based finite element prediction. *Physica E: Low-dimensional Systems and Nanostructures* **43**(10), 1833–1839 (2011)
11. Höller, R., Smejkal, V., Libisch, F., Hellmich, C.: Energy landscapes of graphene under general deformations: DFT-to-hyperelasticity upscaling. *International Journal of Engineering Science* **154**, 103342 (2020)
12. Hossain, M.Z., Ahmed, T., Silverman, B., Khawaja, M.S., Calderon, J., Rutten, A., Tse, S.: Anisotropic toughness and strength in graphene and its atomistic origin. *Journal of the Mechanics and Physics of Solids* **110**, 118–136 (2018)
13. Jiang, S., Shi, S., Wang, X.: Nanomechanics and vibration analysis of graphene sheets via a 2D plate model. *Journal of Physics D: Applied Physics* **47**(4), 045104 (2013)
14. Kang, X., Wang, J., Wu, H., Liu, J., Aksay, I.A., Lin, Y.: A graphene-based electrochemical sensor for sensitive detection of paracetamol. *Talanta* **81**(3), 754–759 (2010)
15. Kausar, A.: Applications of polymer/graphene nanocomposite membranes: a review. *Materials Research Innovations* **23**(5), 276–287 (2019)

16. Koenig, S.P., Boddeti, N.G., Dunn, M.L., Bunch, J.S.: Ultrastrong adhesion of graphene membranes. *Nature nanotechnology* **6**(9), 543–546 (2011)
17. Korobeynikov, S.N., Alyokhin, V.V., Babichev, A.V.: On the molecular mechanics of single layer graphene sheets. *International Journal of Engineering Science* **133**, 109–131 (2018)
18. Kumar, S., Parks, D.M.: On the hyperelastic softening and elastic instabilities in graphene. *Proceedings of the Royal Society A: Mathematical, Physical and Engineering Sciences* **471**(2173), 20140567 (2015)
19. Lee, C., Wei, X., Kysar, J.W., Hone, J.: Measurement of the elastic properties and intrinsic strength of monolayer graphene. *Science* **321**(5887), 385–388 (2008)
20. Li, C., Xiao, J., Guo, T., Fan, S., Jin, W.: Effects of graphene membrane parameters on diaphragm-type optical fibre pressure sensing characteristics. *Materials Research Innovations* **19**(sup5), S5–17 (2015)
21. Liu, G., Jin, W., Xu, N.: Graphene-based membranes. *Chemical Society Reviews* **44**(15), 5016–5030 (2015)
22. Lu, Q., Gao, W., Huang, R.: Atomistic simulation and continuum modeling of graphene nanoribbons under uniaxial tension. *Modelling and Simulation in Materials Science and Engineering* **19**(5), 054006 (2011)
23. Lu, Q., Huang, R.: Nonlinear mechanics of single-atomic-layer graphene sheets. *International Journal of Applied Mechanics* **1**(03), 443–467 (2009)
24. Miculescu, M., Thakur, V.K., Miculescu, F., Voicu, S.I.: Graphene-based polymer nanocomposite membranes: a review. *Polymers for Advanced Technologies* **27**(7), 844–859 (2016)
25. Multiphysics, C.: Introduction to COMSOL multiphysics®. COMSOL Multiphysics, Burlington, MA, accessed Feb 9, 2018 (1998)
26. Ni, Z., Bu, H., Zou, M., Yi, H., Bi, K., Chen, Y.: Anisotropic mechanical properties of graphene sheets from molecular dynamics. *Physica B: Condensed Matter* **405**(5), 1301–1306 (2010)
27. Papageorgiou, D.G., Kinloch, I.A., Young, R.J.: Mechanical properties of graphene and graphene-based nanocomposites. *Progress in Materials Science* **90**, 75–127 (2017)
28. Pellicciari, M., Pasca, D.P., Aloisio, A., Tarantino, A.M.: Size effect in single layer graphene sheets and transition from molecular mechanics to continuum theory. *International Journal of Mechanical Sciences* **214**, 106895 (2022)
29. Pellicciari, M., Tarantino, A.M.: Equilibrium paths for von Mises trusses in finite elasticity. *Journal of Elasticity* **138**(2), 145–168 (2020)
30. Pellicciari, M., Tarantino, A.M.: Equilibrium paths of a three-bar truss in finite elasticity with an application to graphene. *Mathematics and Mechanics of Solids* **25**(3), 705–726 (2020)
31. Pellicciari, M., Tarantino, A.M.: Equilibrium and stability of anisotropic hyperelastic graphene membranes. *Journal of Elasticity* **144**(2), 169–195 (2021)
32. Pellicciari, M., Tarantino, A.M.: A nonlinear molecular mechanics model for graphene subjected to large in-plane deformations. *International Journal of Engineering Science* **167**, 103527 (2021)
33. Pumera, M.: Graphene-based nanomaterials for energy storage. *Energy & Environmental Science* **4**(3), 668–674 (2011)
34. Quanshui, Z., Boehler, J.P.: Tensor function representations as applied to formulating constitutive laws for clinotropic materials. *Acta mechanica sinica* **10**(4), 336–348 (1994)
35. Raccichini, R., Varzi, A., Passerini, S., Scrosati, B.: The role of graphene for electrochemical energy storage. *Nature Materials* **14**(3), 271–279 (2015)
36. Rafiee, M.A., Rafiee, J., Wang, Z., Song, H., Yu, Z.Z., Koratkar, N.: Enhanced mechanical properties of nanocomposites at low graphene content. *ACS Nano* **3**(12), 3884–3890 (2009)
37. Saiz-Bretín, M., Domínguez-Adame, F., Malyshev, A.V.: Twisted graphene nanoribbons as nonlinear nanoelectronic devices. *Carbon* **149**, 587–593 (2019)
38. Shen, H., Zhang, L., Liu, M., Zhang, Z.: Biomedical applications of graphene. *Theranostics* **2**(3), 283 (2012)
39. Tao, L.Q., Zhang, K.N., Tian, H., Liu, Y., Wang, D.Y., Chen, Y.Q., Yang, Y., Ren, T.L.: Graphene-paper pressure sensor for detecting human motions. *ACS nano* **11**(9), 8790–8795 (2017)
40. Wang, D., Fan, S., Jin, W.: Graphene diaphragm analysis for pressure or acoustic sensor applications. *Microsystem technologies* **21**(1), 117–122 (2015)
41. Wang, M.C., Yan, C., Ma, L., Hu, N., Chen, M.W.: Effect of defects on fracture strength of graphene sheets. *Computational Materials Science* **54**, 236–239 (2012)
42. Wang, P., Gao, W., Cao, Z., Liechti, K.M., Huang, R.: Numerical analysis of circular graphene bubbles. *Journal of Applied Mechanics* **80**(4), 040905 (2013)
43. Wang, Q., Hong, W., Dong, L.: Graphene “microdrums” on a freestanding perforated thin membrane for high sensitivity MEMS pressure sensors. *Nanoscale* **8**(14), 7663–7671 (2016)
44. Yanovsky, Y.G., Nikitina, E.A., Karnet, Y.N., Nikitin, S.M.: Quantum mechanics study of the mechanism of deformation and fracture of graphene. *Physical Mesomechanics* **12**(5-6), 254–262 (2009)
45. Yuan, J., Liu, X., Xia, H., Huang, Y.: Analytical solutions for inflation of pre-stretched elastomeric circular membranes under uniform pressure. *Theoretical and Applied Mechanics Letters* p. 100243 (2021)
46. Zang, X., Zhou, Q., Chang, J., Liu, Y., Lin, L.: Graphene and carbon nanotube (CNT) in MEMS/NEMS applications. *Microelectronic Engineering* **132**, 192–206 (2015)
47. Zhao, H., Min, K., Aluru, N.R.: Size and chirality dependent elastic properties of graphene nanoribbons under uniaxial tension. *Nano Letters* **9**(8), 3012–3015 (2009)
48. Zhu, S.E., Krishna Ghatkesar, M., Zhang, C., Janssen, G.C.A.M.: Graphene based piezoresistive pressure sensor. *Applied Physics Letters* **102**(16), 161904 (2013)